

Control Systems

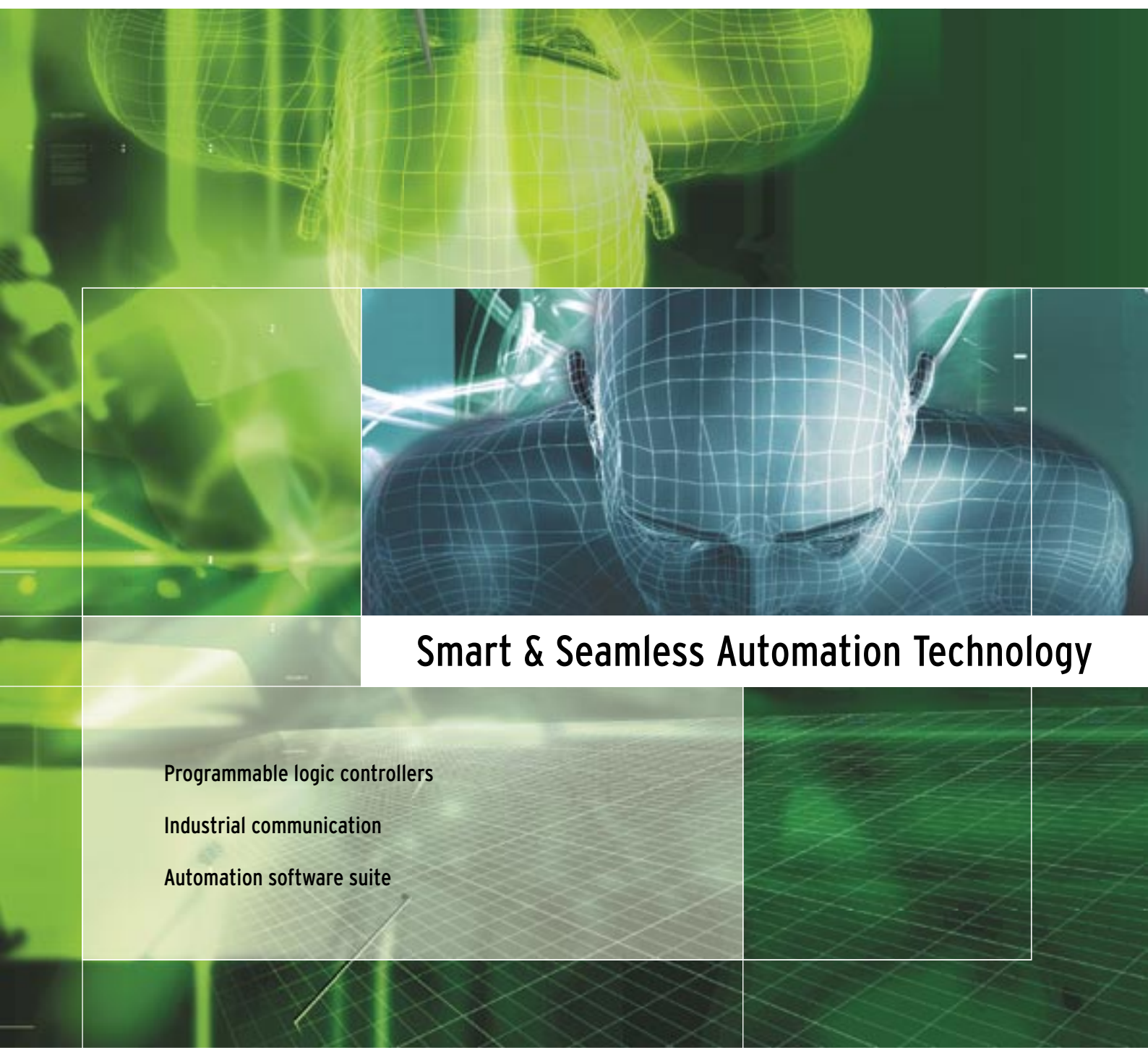

Smart & Seamless Automation Technology

Programmable logic controllers

Industrial communication

Automation software suite

Advanced Industrial Automation

OMRON

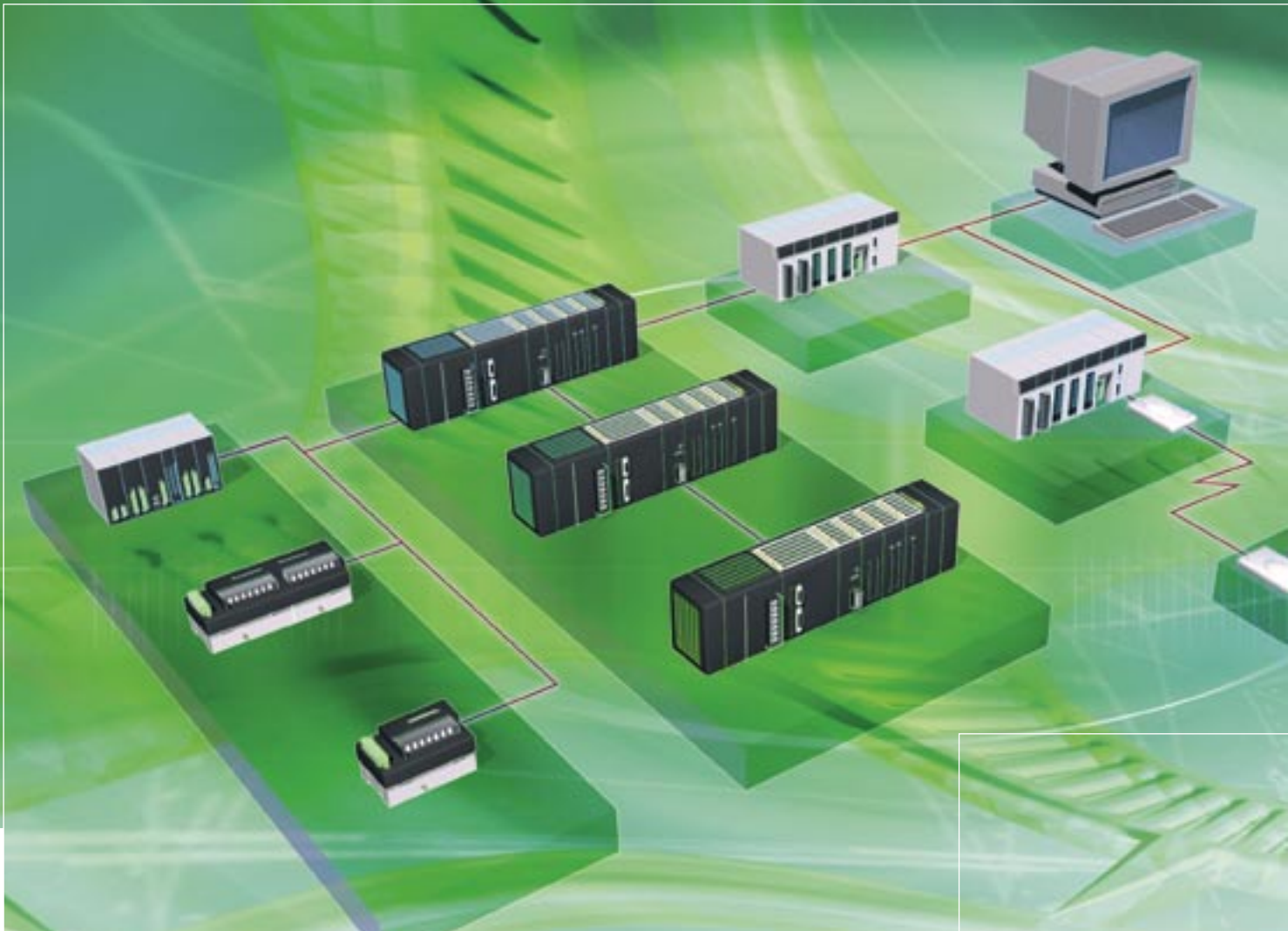

Control Systems - Smart & Seamless Technology

FLEXIBLE, FAST & EFFICIENT SOLUTIONS

Flexibility, efficiency and speed are vital factors for staying competitive in the machine building industry. Omron's Control Systems give you this competitive edge. Omron's reputation for product quality, reliability and advanced technology is inherent in all of its control systems, from the smart remote I/O and the compact CPM to the high-performance modular CJ1 and the backplane-based CS1 series.

These control systems are designed to meet the increasing demands for processing speed and transparency. They provide seamless data exchange inside machines, between machines, between machines and hosts, and between machines and remote locations. What's more, Omron's support software is designed to help you unleash the power and flexibility of these control systems. The CX Automation Suite contains



software tools that enable you to configure, program, commission, visualize and maintain all of Omron's PLCs, and all using the same seamless communication. You simply choose the software tools you need now, and add other software components later. With Omron's control systems you enjoy the benefits of compact, flexible and powerful performance, throughout your entire factory automation system!

- 4 ▶ Compact PLC series**
CPM1 & CPM2 • The compact machine controllers
- 6 ▶ Modular PLC series**
CJ1 • A new strategy in machine control
- 8 ▶ Rack PLC series**
CS1 • The reliable process controller
- 10 ▶ Industrial Networks**
Seamless communication
- 12 ▶ CX Automation Software Suite**
Allows easier modularization of control systems
- 14 ▶ Smart & Seamless Technology**
For seamless communication and smart devices
- 15 ▶ Overview of Omron's PLC Systems**

COMPACT PLC SERIES

CPM1 & CPM2 • The compact machine controllers

The CPM series is Omron's compact PLC range; compact in size, but not in features. All models provide interrupt and pulse input functions for fast detection and counting. All transistor output models provide pulse outputs to drive stepper motors, servo drives or inverters.

The CPM1A is an all-in-one PLC. A range of 24 CPU units is available with AC or DC power supply, built-in DC inputs and transistor- or relay outputs. Built-in interrupt and pulse I/O functions allow for easy counting, positioning, and speed control applications. Expansion I/O units can be attached for additional digital I/O, analog I/O or temperature measurement and regulation. DeviceNet-, PROFIBUS- and CompoBus/S slave units enable the CPM1A to be integrated as a slave controller in field networks.

In addition to having all of the CPM1A functions and expansion options, the CPM2A offers faster pulse I/O (up to 20 kHz), larger I/O capacity and more extensive communication functions. Powerful functions for axis synchronization, pulse width modulation and quick-response inputs make it the ideal small machine controller.

The CPM2C is a compact communication wonder. It includes everything the CPM2A has to offer, in a slim, compact shape. It offers I/O modules with screw- or multi-pole connectors, and CPUs with built-in DeviceNet slave and/or CompoBus-S master functions, to provide truly distributed machine control with unrivalled modularity.



Features CPM series

- Max. 192 inputs/outputs
- 20 kHz counter and two 10 kHz pulse outputs
- Program memory 4 K words
- Data memory 2 K words
- Optional real-time clock
- One or two RS-232C interfaces built in
- Up to 32 CPM2 controllers can easily be networked using Omron's Host Link
- PID, SYNC and pulse-width modulation commands
- Advanced positioning for one axis per CPU

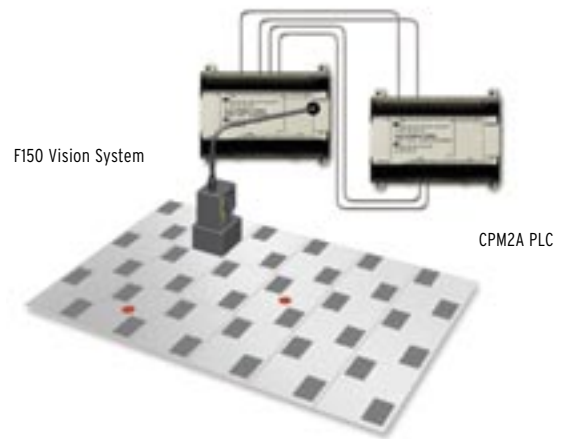
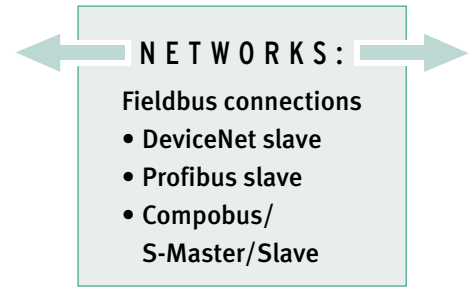

▼ CPM1A's interrupt inputs and 5 kHz pulse counter make it ideally suited for applications like conveyor control, length measurement and sheet cutting.

▲ CPM2A's motion control functions and communication capabilities combined with the compact F150 vision system make a cost-effective high-speed quality inspection system.

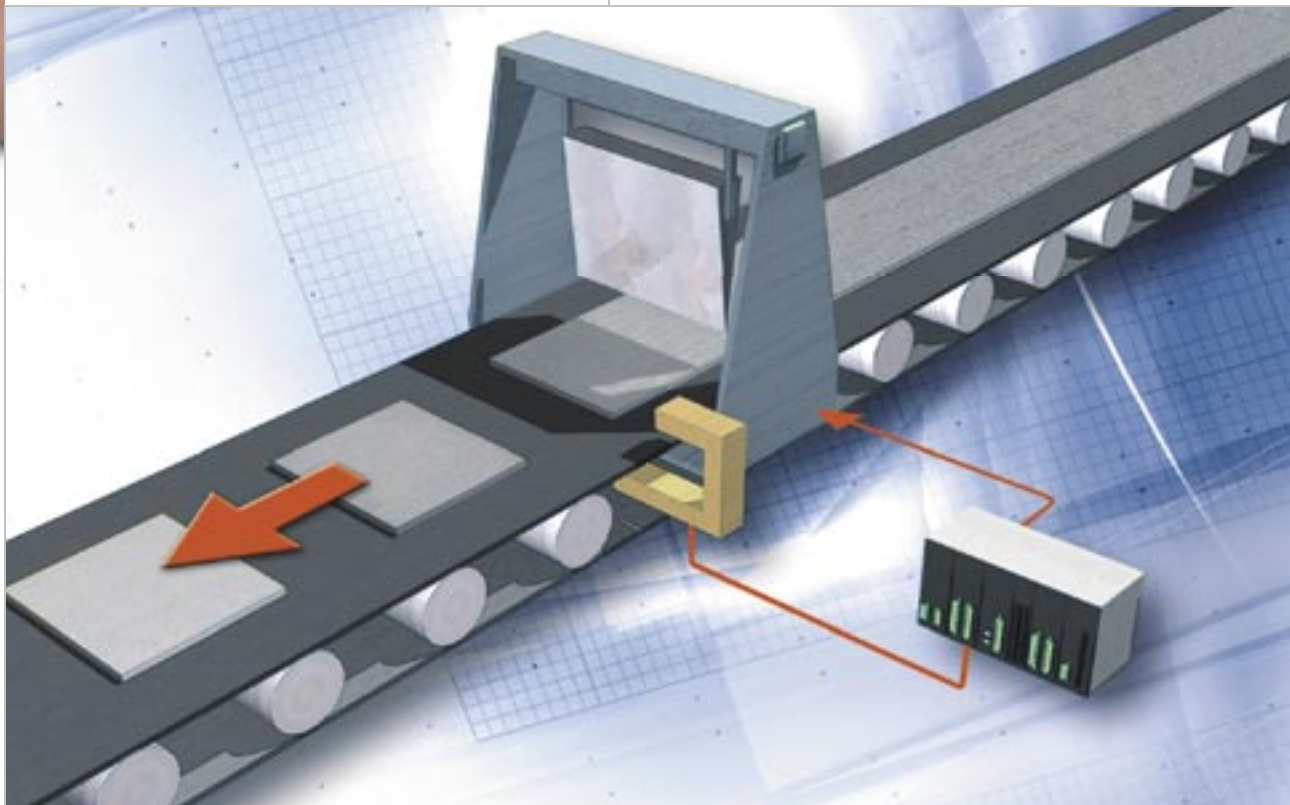

MODULAR PLC SERIES



6

CJ1 • A new strategy in machine control

Sliceable Solutions

The family of CJ1 CPUs ranges from very small CPUs for simple sequence control to powerful and fast models that offer total machine control which can handle up to 2560 I/O points. This enables you to modularize or 'slice' your machine into logical sections without changing PLC series.

You don't even need to consider where to slice the machine: any I/O units can be mounted on any CPU, enabling you to distribute all the functions you need to, wherever you need them. This reduces the number of different modules you have to keep in stock. And no matter how complex your machine becomes, there's always a CPU and a combination of I/Os to match your needs. It's the ultimate in machine sliceability and scalability!

SLICE / ability

The wide range of CJ1 PLC modules includes:

- Open communication units for Ethernet, DeviceNet and PROFIBUS, plus Omron's highly efficient proprietary networks.
- Specialised units for RFID tagging, positioning or temperature control.
- A variety of analogue and digital I/O units with a choice of connection technologies.



Features CJ1

- Max. 2560 digital inputs/outputs
- Wide range of compatible CPUs and I/O units
- One scaleable PLC family to match all your needs
- High-speed CPUs with instruction times down to 20 nanoseconds
- Uses standard CompactFlash memory cards for backup and data logging
- 90mm x 65mm – a profile slightly larger than a credit card
- No backplane required
- Fast and easy to install and configure
- High-performance data exchange and programming using open network systems

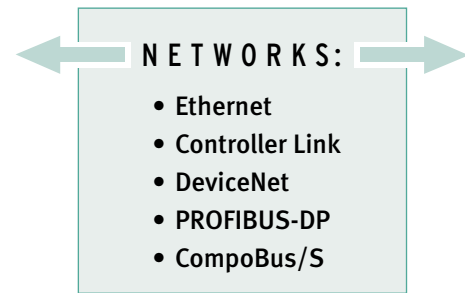

▼ In the CJ1 control units, peripheral processing is performed in parallel with command processing (on left). This helps CJ1 to achieve the fastest response times in its class.

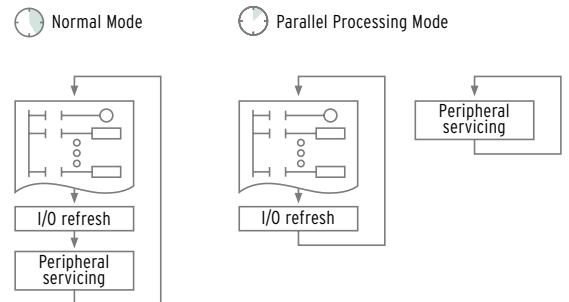

▼ Modular design can reduce a machine builder's costs in development, assembly, and parts stock. Each logical machine section will have different requirements in control speed, capacity, size and functionality. CJ1's wide range will provide a modular and transparent control solution.



RACK PLC SERIES

CS1 • The reliable process controller



8

The CS1-series has evolved from - and is backwards compatible with - the successful C200H-series PLC. Its extensive range of application-oriented units and its powerful instruction set will help you cut down on system development time by always providing an optimal solution with a minimum of programming.

Over 150 different I/O, communication, and special function units are available for the CS1-series. High-density I/O units boost the system's local I/O capacity to a maximum of 5120 I/O points. And using fieldbus systems like DeviceNet and PROFIBUS-DP enables 10.000's of remote I/O points to be added. Processing speeds down to 20 ns per instruction allow you to efficiently manage all this data.

Special function units for programmable continuous-path motion control or point-to-point positioning relieve the CPU and provide high-speed response. Batch and continuous process control functions can seamlessly be combined with conventional PLC sequencing using CS1 loop control units. Configuration is simple and intuitive, using DCS-style block diagrams and faceplates. Communication units allow simple and cost-efficient proprietary networking as well as the flexibility offered by conformance to open standards.

For maximum system availability, the CS1D can be equipped with dual-redundant CPUs, power supplies and communication units, and allows hot-swapping of CPUs and I/O units.



Features CS1

- Max. 5120 digital inputs/outputs
- Max. 640 analogue inputs/outputs
- Program memory up to 250 K steps (1 MB)
- Data memory up to 448 K words
- Uses CompactFlash memory cards for backup and data logging
- E-mail using Internet (SMTP protocol)
- CS1 special I/O modules such as Motion Controller can be programmed over any network

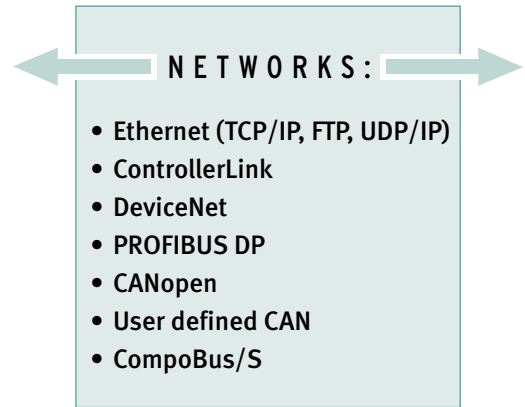

▶ Continuous and batch control function blocks can be seamlessly integrated with PLC sequence control by using CS1's Loop Control Units.

▼ The MC402 is an advanced motion control unit capable of controlling up to 4 axes. Its powerful functionality includes cam profiling, electronic gearbox, registration and multi-axis synchronization. Embedding this type of high function motion control into a PLC module brings the advantages of smaller panel size and simpler wiring and enables real time sharing of information.

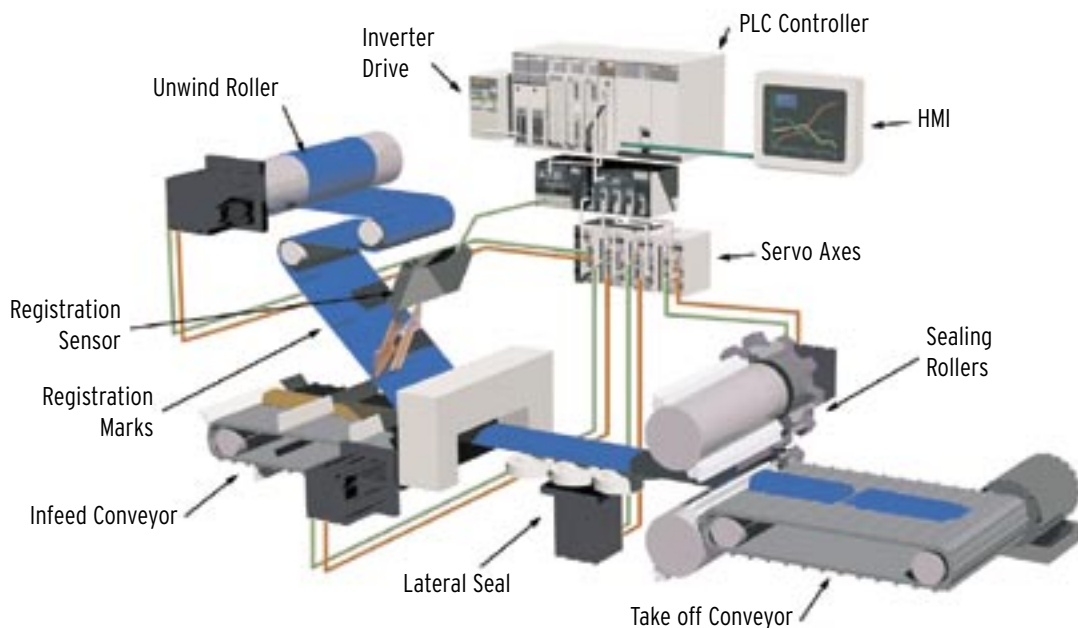
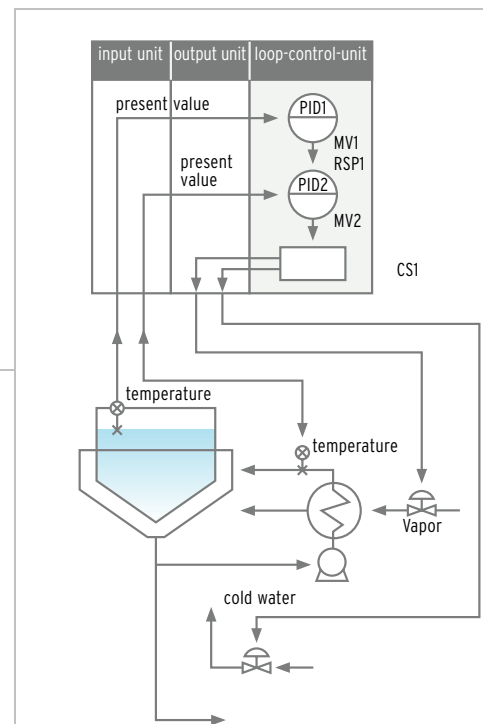

INDUSTRIAL NETWORKS

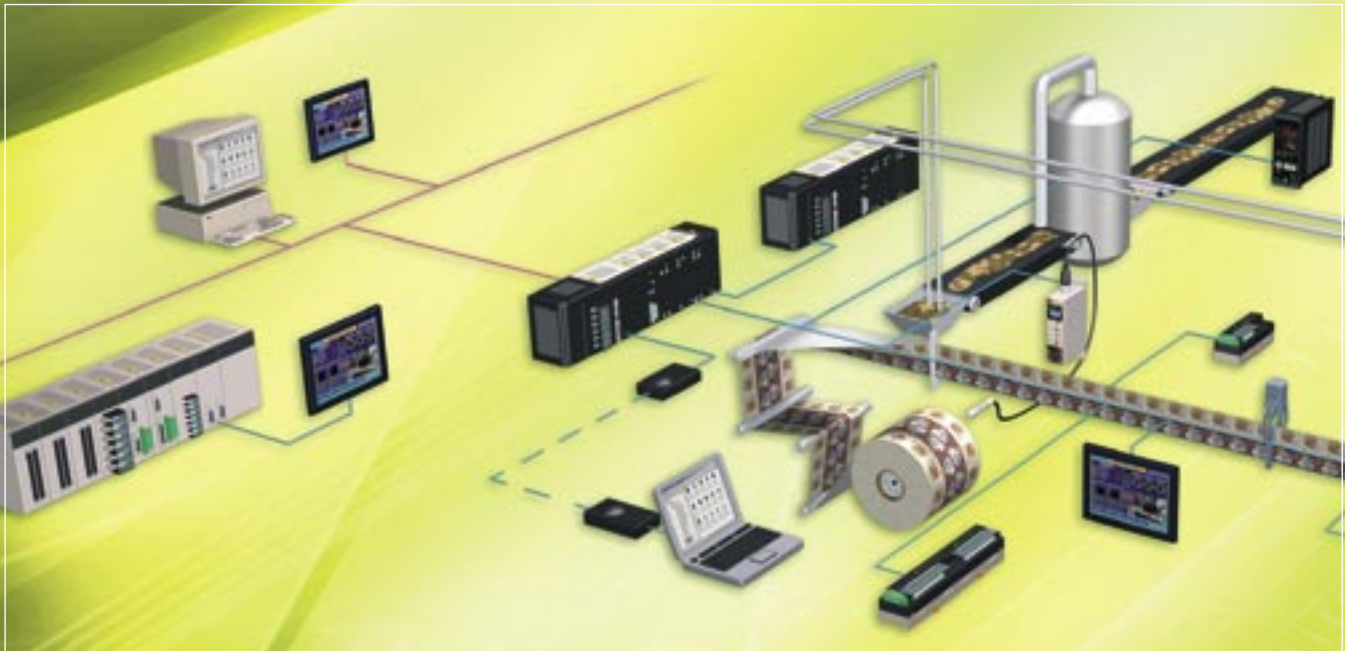

Smart & Seamless communication

10

Flexibility

Omron's products support a wide range of networks including the bitbus Compobus/S (currently the fastest in the market), the DeviceNet and Profibus open fieldbuses, the MC-High motion bus, the easy-to-use Controller Link and of course Industrial Ethernet.

Transparent Communication

FINS (Factory Intelligence Network Service) is Omron's network independent communication protocol and is supported by Omron's PLCs, HMI terminals and Software Suite. It provides direct access to programs, configuration parameters and all other readable or writable data. FINS can access

any control element via modem, Ethernet, Controller Link and DeviceNet with one and the same command, and is thus network independent.

Smart I/O

DeviceNet I/O units from Omron (DRT2) help to reduce system troubleshooting costs. These DeviceNet I/O slave units provide advanced built-in diagnostics and maintenance functions. This built-in functionality provides users with detailed diagnostic and maintenance data without any additional PLC programming, thus providing a simple way for users to schedule preventive maintenance and reduce troubleshooting.



Features FINS

- Direct access to data and programs
- Transparent communication through different networks allows access beyond network borders
- Remote
- Supported by Omron's PLCs, HMI terminals and Software Suite

▼ Omron's smart I/O modules.



DeviceNet™

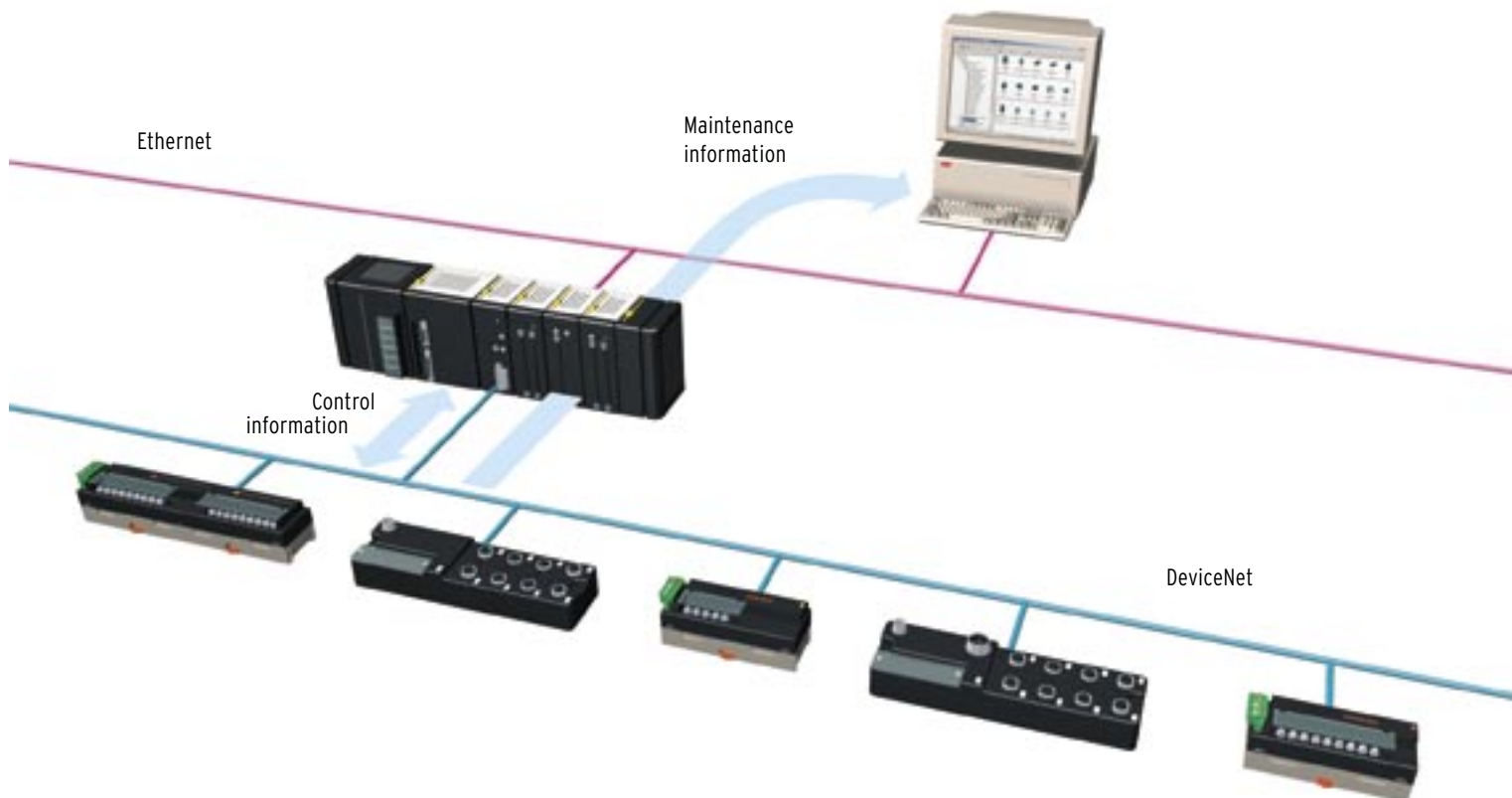

▲ Omron's DRT2 series feature integrated preventive maintenance functions.

CX-AUTOMATION SUITE SOFTWARE

Powerful use of advanced industrial control systems

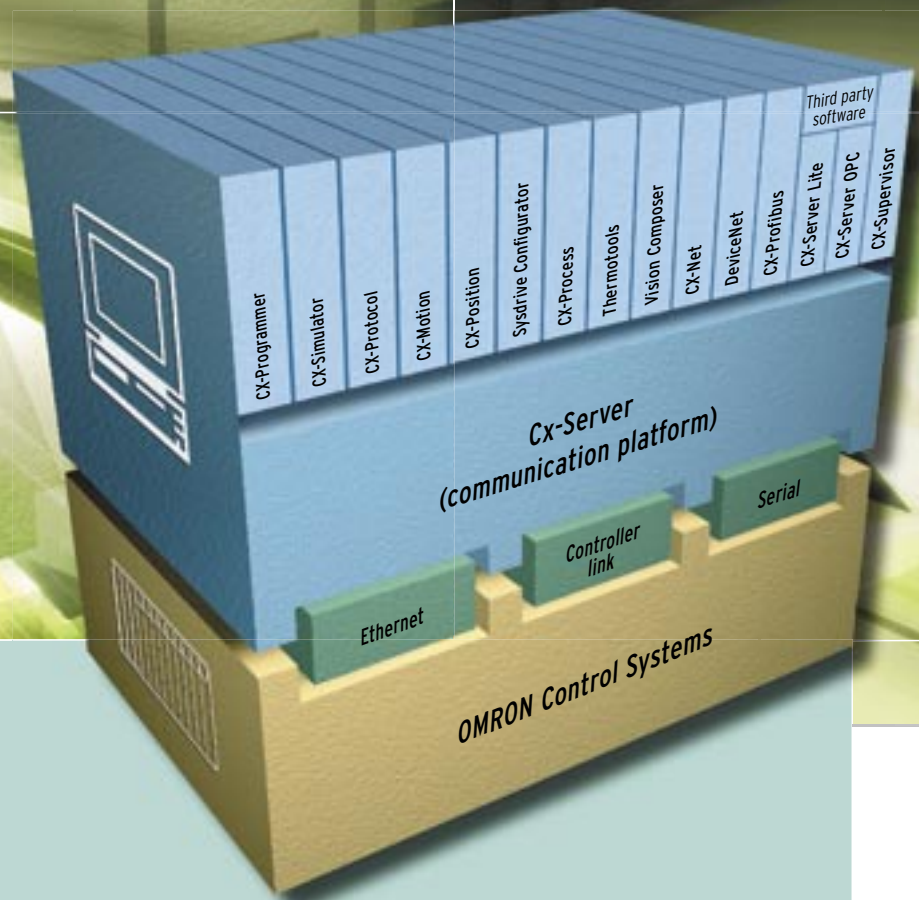

Omron's CX-Automation Suite allows easy configuration of powerful advanced industrial control systems. The suite contains drivers for all Omron communications networks (Ethernet, Controller Link, Serial, etc.) ensuring a seamless and transparent connection regardless of the type of network or device. The CX-Automation Suite integrates process information and business information effortlessly, enabling users to combine data in familiar applications such as spreadsheets.

Any authorized user with a notebook can connect to the network and acquire information, visualize processes or adjust settings. With the CX-Automation Suite building a network requires less programming knowledge and less programming time. The high degree of standardization and use of generic software means that any network can be adapted and extended quickly in almost any new direction.

CX-Software Features

- CX-Automation suite communications architecture allows simultaneous data access from multiple control programs
- Contains drivers for all Omron communications networks (Ethernet, Controller Link, Serial)
- Uniform operating structure and data sharing
- Ease of use operation but with powerful functionality
- Built-in features to diagnose faults and reduce downtime
- Remote maintenance or connection to production information from anywhere in the world

CX-Automation Suite

- ▼ CX-Server Lite
- ▼ CX-Server OPC



Item	units	unit cost	total
Paint	600	3.00	1,800.00
wood	70	7.00	490.00
fastners	70	2.00	140.00
labels	40	15.00	600.00
oil	1	7.00	7.00
screws A	15	2.50	37.50
screws B	400	4.00	1,600.00
naps	20	8.25	165.00
bumpers	20	3.50	70.00
(A) Total cost Jersey			2,999.00

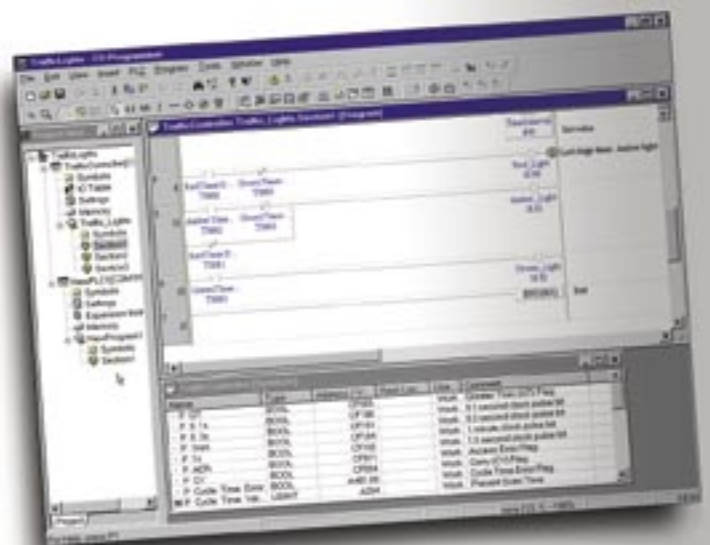

SMART & SEAMLESS TECHNOLOGY

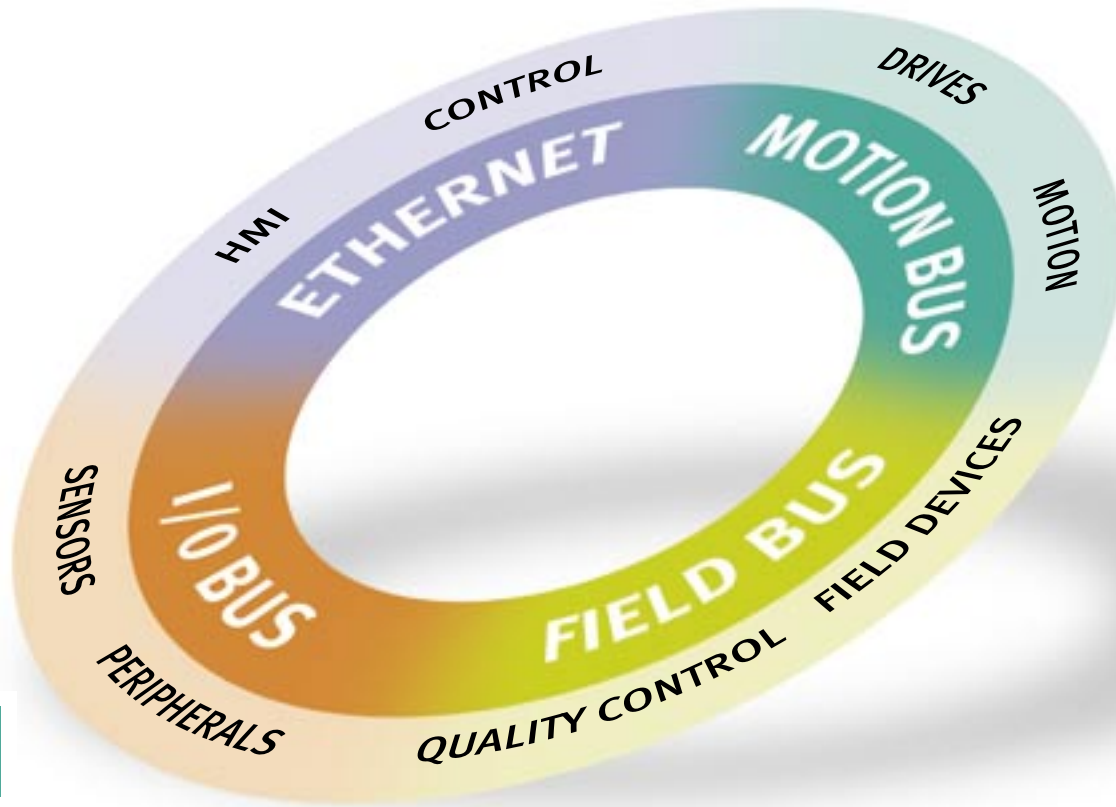

14

Transparency and integration for machine automation

The Smart & Seamless Technology (SST) concept supplies solutions for machine automation with the emphasis on ease-of-use and a high degree of integration between devices. This technology is device-centric, and regards system architecture as an information highway where different field networks feed into each other seamlessly.

SST is the ideal solution for system engineers faced with the challenge of delivering customised machines or installations. SST provides modular control systems for separate machine parts. It offers customised solutions without a significant increase in integration time or complexity. And it enables machines to be built without extended programming. This leads to important cost savings in the creation of tailored solutions that satisfy both the price and performance requirements of the most discerning customer.

COMPLETE OVERVIEW OF PLC FAMILIES

		Compact PLC series CPM1/CPM2	Modular PLC series CJ1	Rack PLC series CS1
Built-in	Digital I/O	10 - 60	0 - 16	n.a.
	Counter inputs	5 - 20 kHz	100 kHz	n.a.
	Pulse outputs	2 - 10 kHz	100 kHz	n.a.
Max. digital I/O points		10 - 192	320 - 2560	960 - 5120
Execution time (bit instructions)		0.72 - 0.64 μ s	0.10 - 0.02 μ s	0.04 - 0.02 μ s
Program memory		2 - 4 k words	10 - 120 k steps	10 - 250 k steps
Data memory		1 - 2 k words	32 - 256 k words	32 - 448 k words
CompactFlash memory		n.a.	Up to 64 MB	Up to 64 MB
Analogue I/O		Up to 4 x 3 points 8-bit, 12-bit resolution U, I, TC, Pt100	Up to 40 x 8 points 12/13 bit resolution U, I, TC, Pt100	Up to 80 x 8 points 12/13 bit resolution U, I, TC, Pt100
Special function units			Temperature control High-speed counters (500 kHz) Position control Protocol macro	Temperature control SSI encoder input High-speed counters (500 kHz) Position control Motion control Process control Protocol macro Freely programmable units
Industrial Networks		Serial Communications	Ethernet Controller Link Serial Communications	Ethernet Controller Link Serial Communications
Fieldbus master		CompoBus/S	DeviceNet CompoBus/S PROFIBUS-DP (Q3 - 2003)	DeviceNet CompoBus/S PROFIBUS-DP CAN / CAN open
Field bus I/O Link		DeviceNet CompoBus/S PROFIBUS-DP	DeviceNet PROFIBUS-DP	DeviceNet PROFIBUS-DP CAN / CANopen

OMRON EUROPE B.V. Wegalaan 67-69, NL-2132 JD, Hoofddorp, The Netherlands. Tel: +31 (0) 23 568 13 00 Fax: +31 (0) 23 568 13 88 www.europe.omron.com

Austria

Tel: +43 (0) 1 80 19 00
www.omron.at

Belgium

Tel: +32 (0) 2 466 24 80
www.omron.be

Czech Republic

Tel: +420 267 31 12 54
www.omron.cz

Denmark

Tel: +45 43 44 00 11
www.omron.dk

Finland

Tel: +358 (0) 9 549 58 00
www.omron.fi

France

Tel: +33 (0) 1 49 74 70 00
www.omron.fr

Germany

Tel: +49 (0) 2173 680 00
www.omron.de

Hungary

Tel: +36 (0) 1 399 30 50
www.omron.hu

Italy

Tel: +39 02 32 681
www.omron.it

Netherlands

Tel: +31 (0) 23 568 11 00
www.omron.nl

Norway

Tel: +47 (0) 22 65 75 00
www.omron.no

Poland

Tel: +48 (0) 22 645 78 60
www.omron.com.pl

Portugal

Tel: +351 21 942 94 00
www.omron.pt

Russia

Tel: +7 095 745 26 64
www.russia.omron.com

Spain

Tel: +34 913 777 900
www.omron.es

Sweden

Tel: +46 (0) 8 632 35 00
www.omron.se

Switzerland

Tel: +41 (0) 41 748 13 13
www.omron.ch

Turkey

Tel: +90 (0) 216 474 00 40
www.omron.com.tr

United Kingdom

Tel: +44 (0) 870 752 08 61
www.omron.co.uk

For the Middle East, Africa and other countries in Eastern Europe, Tel: +31 (0) 23 568 13 00 www.europe.omron.com

Authorised Distributor:

Automation and Drives

- Programmable logic controllers • Networking
- Human-machine interfaces • Inverter drives • Motion control

Industrial Components

- Electromechanical relays • Timers • Counters • Sockets
- Programmable relays • Low voltage switch gear • Power supplies
- Temperature & process controllers • Solid-state relays
- Panel indicators • Level controllers • Industrial switches • Pushbutton switches

Sensing and Safety

- Photoelectric sensors • Proximity sensors • Rotary encoders
- Vision systems • RFID systems • Safety switches
- Safety relays • Safety sensors

Although we strive for perfection, Omron Europe B.V. and/or its subsidiary and affiliated companies do not warrant or make any representations regarding the correctness or completeness of the information described in this document. We reserve the right to make any changes at any time without prior notice.

PGB06_PL_C_ENG_INT02_0603

OMRON